



**I-MAX**

2D AND 3D/2D WALL-MOUNTED PANORAMIC UNITS

KEEP YOUR CLINIC ONE STEP AHEAD!



Wall-mounted concept: zero foot print



62kg - the lightest unit on the market



"Face to face" positioning



High Definition



The fruit of unrivalled technological and industrial expertise, the latest generation of I-Max panoramic systems (2D or 3D/2D) is here to usher you into a new era.

#### **Futuristic design coupled with ergonomics**

Its sleek, sophisticated and lightweight design makes the I-Max an attractive and valuable asset for your clinic. With the 2D version weighing just 62kg, the I-Max is the lightest panoramic unit on the market. As with your intraoral generator, it is wall-mounted and connects to your network without the need for a dedicated PC.

#### **Exceptional image quality**

It's more than just an innovative design. With the I-Max you can carry out all the examinations you need for your patients, and enjoy ultra-high definition images in every X-Ray. You'll be able to view all clinical and anatomical details with maximum precision and your diagnostics will be conducted in complete safety.



### **Patient positioning made easy**

Poor patient positioning is the reason behind the majority of failed images. As well as lasers and temple clamps, the unit places patients face-on, ensuring the perfect positioning. Patients with reduced mobility will also find the system easier to use and move around, as it takes up no floor space.



## INNOVATIVE TECHNOLOGY WITH YOUR BUDGET UNDER CONTROL

**ALI-S** ALI-S system



Intuitive interface



The best Performance/Investment ratio



Software compatibility



### **Powers of innovation**

Incorporating ALI-S (Automatic Layers Integration System), the unit directly and automatically selects the best sections in order to display a perfect image, without any form of operator involvement.

Another of the I-Max's unique features is its intuitive and user-friendly HMI (Human-Machine Interface), whereby its imaging tools and enhancing filters are automatically integrated into the control software. Even more appealing is I-Max's compatibility with every kind of management software on the market.

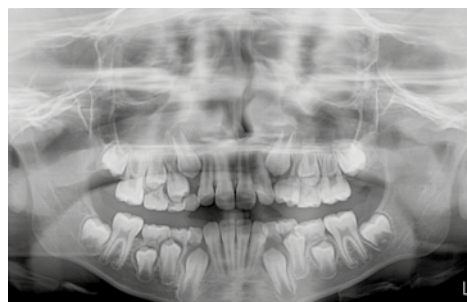

Child's panoramic examination



### **Easy to install and use**

This ultra-compact and lightweight system comes in one easy-to-handle package. Featuring an exclusive “Easy to Install” system, the I-MAX panoramic unit is delivered to your clinic fully assembled, requiring just one technician to install it in situ.

An installation video is provided on our website and on our YouTube channel, Owandy Radiology. Brimming with technological developments, all of its electronic components have been fully optimised. The I-Max minimises the risk of system failures and facilitates maintenance work.

### **A controlled, balanced budget**

The result of optimised manufacturing processes, the new I-Max clearly offers the best Performance/Investment ratio, with lower purchase, delivery and installation costs and easier maintenance. We haven't compromised on image quality, however, which guarantees ultra-high definition results.

So now you can offer your patients a comprehensive range of services, regardless of how big or small your clinic!



Also available with mounting column

## 2D PANORAMIC UNIT – THE ULTIMATE IN ADAPTABILITY

**3D/2D** 2D → 3D/2D mode

**2D**  
x24 24 2D programs



Control over your budget



Intuitive interface

# I-MAX

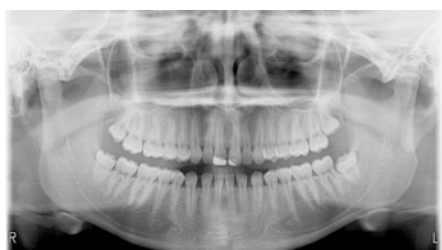

Adult panoramic examination

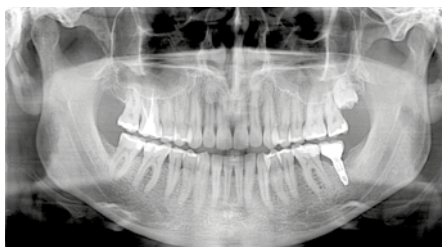

Low dose panoramic examination

### 2D programs to suit all your dentistry needs

The I-Max is designed to conduct the full range of examinations your practice demands:

- Standard panoramic
- Right/left half-sides panoramic
- Reduced dose panoramic
- Panoramic with improved orthogonality
- Standard bitewing
- Right/left half-sides bitewing
- Frontal dentition
- Maxillary sinus examination
- TMJ examinations



### Need to change?

The I-Max panoramic unit adapts to suit your particular requirements at any time. It switches easily from the standard 2D version to a 2D/3D Cone Beam mode – whenever you want!

### Maximum technology in a minimum of space

Because this highly compact I-Max panoramic unit weighs just 62kg and boasts a "zero foot-print" concept, it's easy to walk around freely.

It offers the best Performance/Investment ratio, so why not treat your clinic to this state-of-the-art panoramic unit and still know that your budget's under control?

### Easy to use

The intuitive interface makes the I-Max panoramic unit and its operation extremely easy to master.

You can find all our demo videos on our website and on our YouTube channel, Owandy Radiology.



Intuitive interface and user-friendly

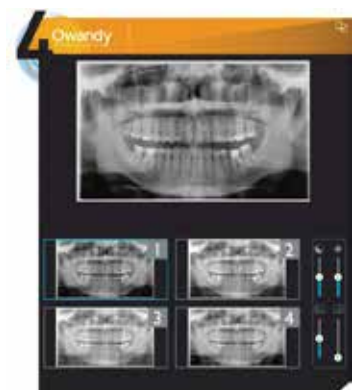

Choice of image processing

NOW EVERYONE CAN DO 3D IMAGING!



Multi-FOV from 12x10\* to 5x5 cm



3D Cone Beam



High Definition



16 3D programs

**I-MAX<sup>3D</sup>**



12x10cm adult 3D exam

Often considered too bulky and extravagant in the past, 3D imaging is today no longer reserved for an elite few. The 3D/2D I-Max has popularised this technology, making it a realistic option for everyone. You, too, can make the leap to the 3D era!

### High resolution multi-FOV 3D Cone Beam imaging

The I-Max 3D allows you to conduct examinations with various volumes, depending on your practice needs:

- ideal for implantology: 12x10cm for a full mouth and condyle (optional), 9x9cm for a full mouth, 9x5cm for a full arch,
- also suitable for endodontics, with its small 5x5cm volume.

All options boast an excellent resolution quality of up to 87µm.

What's more, its ultra-sensitive sensor coupled with an extremely short exposure time helps to considerably reduce X-Ray dose emissions.

\* Optional



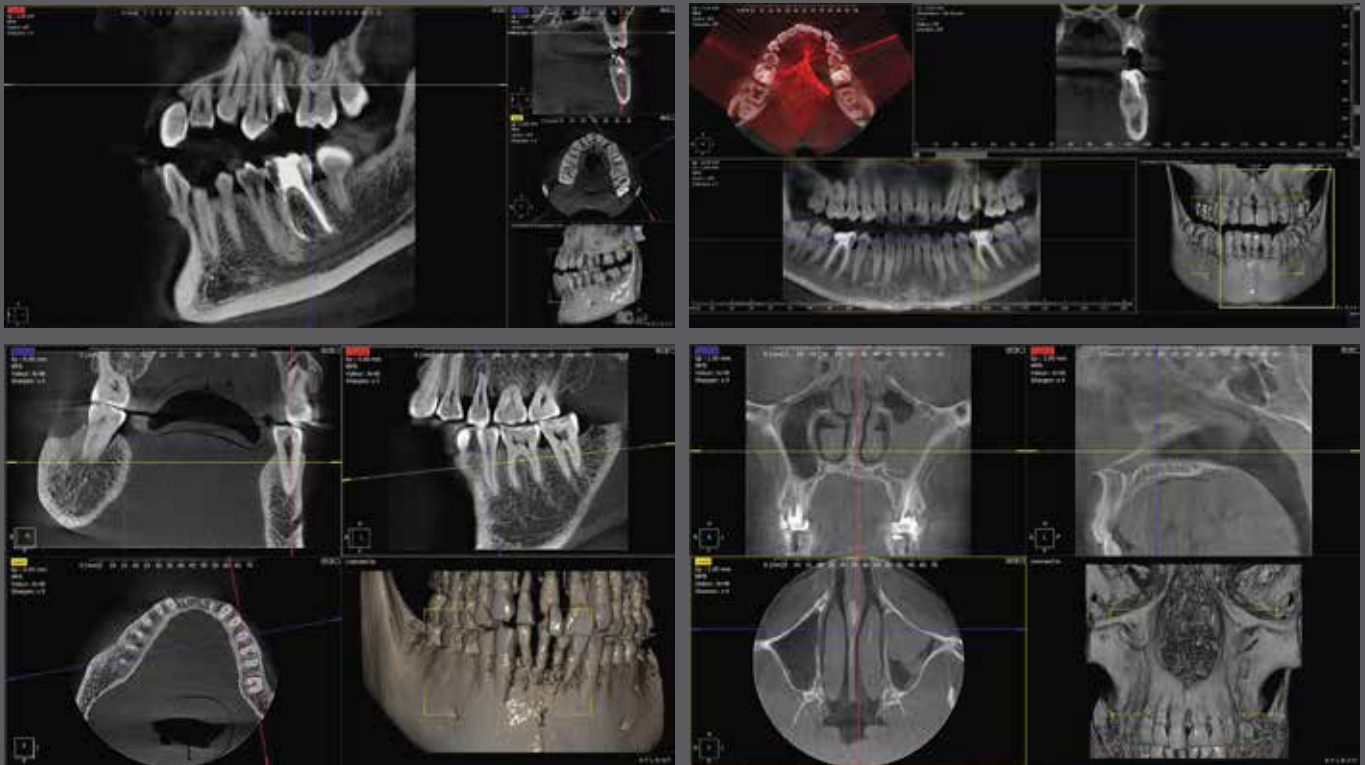

## A multitude of 3D programs at your fingertips

The I-Max 3D enables you to probe deeper for more accurate diagnostics:

- Complete dental volume
- Left / right TMJ
- Sinus
- Maxillary volume / Mandibular volume
- Frontal maxillary
- Left / right premolar maxillary
- Left / right molar maxillary
- Frontal mandibular
- Left / right premolar mandibular
- Left / right molar mandibular



16 3D programs

## 3D CONE BEAM – AND MUCH MORE BESIDES!



CAD/CAM Ready



Surgical guides



3D digital models



Face Scan Ready

# I-MAX<sup>3D</sup>

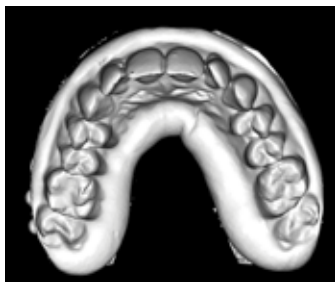

Impression tray model scan

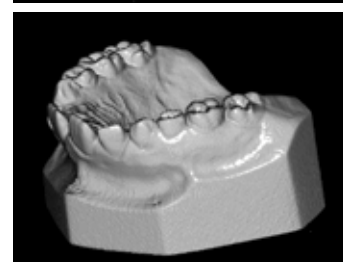
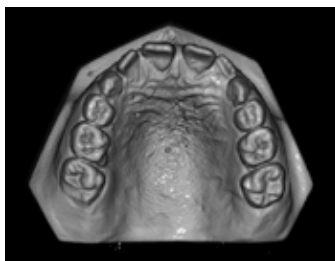

Plaster model scan

### Scan of impression trays, plaster models and radiological guides

The I-Max 3D has been designed with a wide range of ingenious programs to help you get the most out of your day-to-day practice. You can scan 3D models to help you set up a treatment protocol for your patients and make surgical procedures easier. You can also export them in STL format, for use with external modelling software.

### Face Scan Ready\*

Thanks to Face Scan, the communication with your patients is facilitated. You can import .PLY or .OBJ files into your 3D software and associate the corresponding 3D volume. In addition to increasing confidence in your expertise and know-how, your patient will project himself more easily, to accept the suggested treatment plan.

\*.OBJ or .PLY file must come from a third-party device

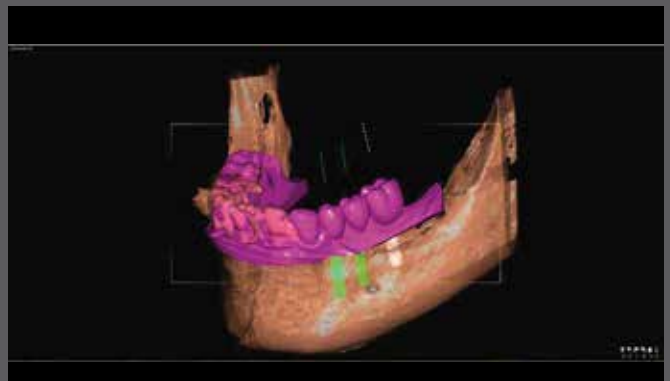
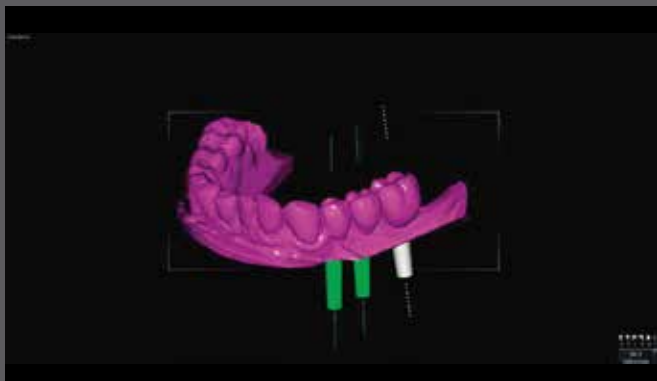

### All-powerful software

Much more than just a 3D radiology machine, the I-Max 3D and its software are designed to create surgical guides quickly, ready to print. It allows you to insert implants quickly and safely for both completely and partially toothless patients.

QuickVision 3D is a comprehensive software package that can be used to simulate implant placement on 2D and 3D models. You can also import STL files from your laboratory and your dental impression camera. The QuickVision 3D implant planning software will prove your most trusted ally for quicker, safer and more efficient prosthetic implant dentistry. The cutting-edge functionalities of the QuickVision 3D software, such as oblique MPR\*\* mode, coupled with its compact 5x5cm volume, will enable you to view cross-section images of patients' teeth, particularly in endodontics.

Your DICOM images are also easy to integrate into the leading 3D software packages such as SimPlant® and Nobel®. You can find all our demo videos on our YouTube channel, Owandy Radiology.



Face Scan (9x9cm)



Face Scan (12x10cm)

\*\*Multiplanar reconstruction

## TECHNICAL INFORMATION

	I-Max 2D	I-Max 3D/2D
Class	II B / CE0051	
Power supply	110-120 V, 220-240 V to 50/60Hz	
Anode voltage	60 ÷ 70 kV	60 ÷ 86 kV
Anode current	2 ÷ 7,1 mA	2 ÷ 12.5 mA
SID (Source to Image Distance)	500 mm	520 mm
Total weight (wall-mounted version)	62 kg	66 kg
Inherent filtration	>2mm Al eq. @ 70kVp	≥2,5mm Al. eq @ 86kVp
HF generator	Constant potential (DC)	
X-Ray focal spot	0.5 mm EN 60336	
Connection	LAN, Ethernet (no dedicated PC required)	LAN, Ethernet (dedicated PC required)
Voxel	N/A	87 µm (min. cross-section depth)
Exposure time	From 2,44 to 14.4 s (PAN Adult / Child)	From 3,20 to 14.4 s (2D exams) From 10,8 to 11,2 s (3D exams)
F.O.V	N/A	∅116x102* / ∅86x93 / ∅86x50 / ∅50x50 mm

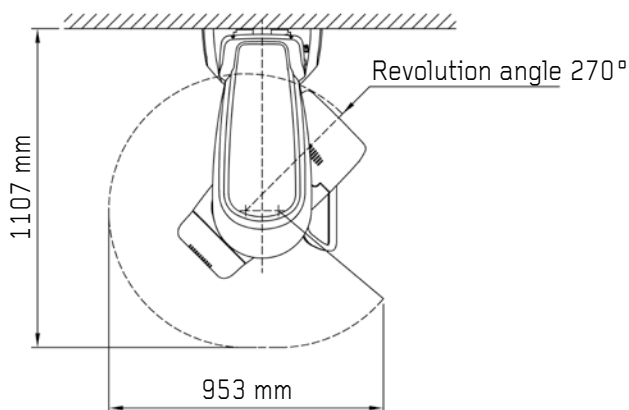
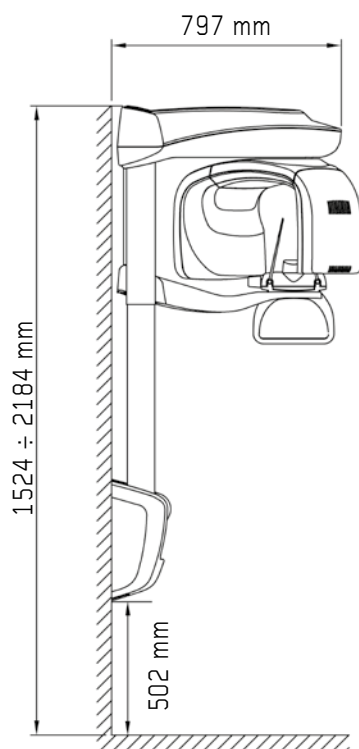

Class IIb / CE0051 medical equipment  
Please read the user instruction manual carefully.

\* optional



BR\_IMAX3D\_EN\_REV02

Dealer

### Owandy Radiology

2, rue des Vieilles Vignes  
77183 Croissy-Beaubourg  
FRANCE  
Tel.: +33 (0)1 64 11 18 18  
Fax: +33 (0)1 64 11 18 10  
info@owandy.com  
www.owandy.com



DIGITAL SENSORS  
IMAGE PLATE SCANNER  
2D -3D PANORAMICS  
INTRA-ORAL RADIOLOGY  
CAMERAS  
SOFTWARE